

# Suction Machine

(MODEL: 9E-A/9E-B)

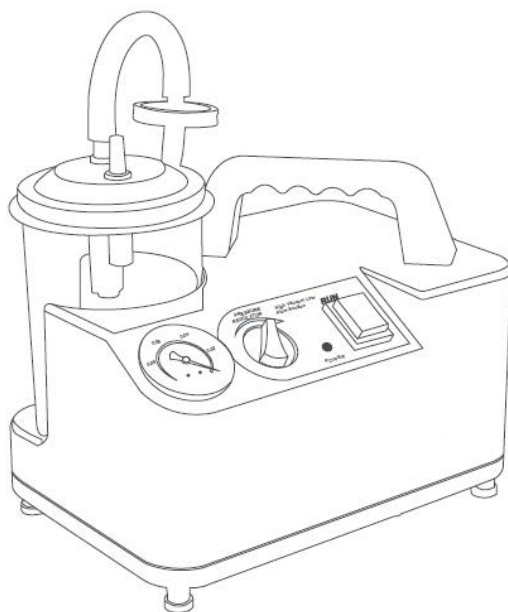

Please read the instruction carefully before use

## **Table of Contents**

<b>Section 1 Introduction.....</b>	<b>1</b>
<b>Section 2 Symbols and specifications.....</b>	<b>3</b>
<b>Section 3 Cautions and Warnings.....</b>	<b>4</b>
<b>Section 4 How to use the electrical suction unit.....</b>	<b>8</b>
<b>Section 5 Cleaning, disinfection and sterilizing.....</b>	<b>17</b>
<b>Section 6 Limited warranty.....</b>	<b>21</b>
<b>Appendix A – Guidance and manufacturer’s declaration of EMC.....</b>	<b>23</b>
<b>Appendix B – Periodic safety overflow mechanism check.....</b>	<b>28</b>

# Section 1 Introduction

## Device Description

Suction Machine is a portable electrically powered aspirator.

The mechanical portion of the electric suction device consists of an electrically driven pump to provide suction, a gauge to indicate the suction level and a regulator to control the suction level. A rigid disposable canister for the collection of phlegm is included as an accessory.

## Intended Use

The device uses suction as a means to withdraw phlegm from a patient. The primary intended use is as an aspirator to be used to help evacuate saliva, mucous, vomitous or other aspirant from the mouth and or airway to allow adequate respiration or ventilation of the patient.

The aspirator is intended to be used for sucking pus, blood, sputum and other viscous liquids (not applicable for abortion attraction) and is intended to be used by trained professionals; Patients range from adults to the elderly and the intended users are trained professionals.

The device is intended for the application of low flow suction with a suction capacity of 15 liters per minute and a maximum vacuum up to -75kPa (-563mmHg).

## Introduction

This introduction For Use (IFU) contains important information regarding safe and effective operation. This manual is intended to aid with training of personnel and provide a reference for experienced users. Also included are instructions for commissioning the device, preventative maintenance, and cleaning and disposal.

**Note: It is important that IFU be kept with the device or the immediate vicinity.**

















Operational safety and efficacy depends not only the ability of the treating clinician, but also on the care and maintenance of the device. Regular cleaning and service will assure continued performance and safety of the suction machine.

## **Package Contents**

- 1 Suction Device
  - 2 Instructions For Use
  - 3 1000ml Bottle (including 1000ml jar, pump-canister tubing, overflow protection)
  - 4 Air Filter
  - 5 Power Cable
  - 6 Fuse
  - 7 Connectors
  - 8 Connection tubes( 2 m length)
  - 9 Sputum suction tube (8\*460mm 12\*460mm)
- If any of these items are missing, contact your distributor.

## Section 2 Symbols and specifications

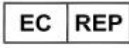
**Note: Some symbols may not appear on your equipment.**

Symbol	Explanation	Symbol	Explanation
	Caution		Increase or decrease (Knob)
	Fragile-handle with care		Type B applied part
	Keep dry		Operating instructions
	This side up		Class II equipment
	ON (power)		Batch code
	OFF (power)		Date of Manufacturer
	Alternating current		Manufacturer
	Authorized representative in the European Community		Marking of electrical and electronic equipment in accordance with 2012/19/EU (WEEE)

## Section 3 Cautions and Warnings

Cautions and Warnings contain important information for the safe operation and use of this product. Do not use this product without first completely reading and understanding these instructions. If you are unable to understand the Dangers, Warnings, Cautions or Instructions, contact the manufacturer or an authorized service dealer before attempting to use this equipment - otherwise, injury or damage may occur.

When using electrical products, basic safety precautions should always be followed, including the following.

### Warnings:

- 3.1 Switch is not a safety disconnecting switch, the MAINS plug is used as the disconnect device, always remain plug readily operable. Use plug as the intended isolation means.  
The equipment is switched completely only by disconnecting the power supply from the wall socket. The wall socket has to be easily accessible.  
**WARNING: To avoid the risk of electric shock, this equipment must only be connected to supply mains with protective earth.**
- 3.2 Only trained medical personnel instructed in aspiration techniques and in the use of medical suction equipment should operate the device. Incorrect use can cause serious bodily harm.
- 3.3 Equipment not suitable for use in the presence of flammable mixtures.
- 3.4 Do not use the device in the presence of a flammable anaesthetic mixture with air or with oxygen or with nitrous oxide.
- 3.5 Do not use oxygen with this system.
- 3.6 Do not use the device in the place filled with inflammable gases, anaesthetics and NO gas.
- 3.7 **WARNING: No use-serviceable parts inside, before servicing to authorized representative or manufacturer!**  
Never operate this product if
  - a) The power cord or the plug is damaged.
  - b) The device is not working properly.
  - c) The device has been dropped or damaged.

- d) The device fell into water.
- e) If the device sounds aloud or sharply suddenly, and if the output air is too hot or smells bad.
- f) Never use a device with a clogged nozzle.

In the above-mentioned cases return the device to the manufacturer or an authorized service dealer for inspection and repair. Don't open the device and change any part yourself.

- 3.8 Device is only used for adults.
- 3.9 **CAUTION: Use of disinfectant recommended by the use manual and clinic verification.**
- 3.10 Malfunctions and a lack of biocompatibility may result if third-party articles are used. Please bear in mind that in these cases any warranty entitlement and liability shall lapse where the accessories recommended in the instructions for use or original spare parts are not utilized.
- 3.11 **CAUTION:**  
**To avoid infection or contamination with bacteria please following Hygienic preparation section.**  
**To reduce the risk of increased bacterial growth, infection, illness, or injury from contamination, thoroughly clean, disinfecting, sterilizing and dry all reusable detachable parts of the device and thoroughly dry any moisture or condensation in the tubing at the end of every treatment, following the instructions for clean, sterilization or disinfection.**  
**Never sterilize the motor unit in an autoclave.**  
**Never dip the motor unit in disinfectant solution.**
- 3.12 Electric equipment should never be left unattended when plugged in. Always unplug this product immediately after using.
- 3.13 Do not use this device in medical rooms where potential equalization is necessary (e.g. heart surgery).
- 3.14 During the aspiration process, take particular care not to cause injuries to the patient's mouth or throat, e.g. to mucous membrane. The nozzle should be provided with fingertip used to interrupter operation by briefly opening the fingertip, for example if the nozzle becomes firmly attached to the skin.
- 3.15 The disposal of liquids such as secretions and any items contaminated with such liquids should be carried out according to the national guidelines for hygiene.

- 3.16 The overflow valve in the canister lid will close down when the canister is full.  
The device should only be operated in the upright position, in order to prevent liquid from wetting the overflow valve filter integrated in the cover of disposable collection bottle. If this happens, the overflow valve filter becomes impermeable to air and the disposable collection bottle cover has to be changed.  
During aspiration, keep an eye on the fluid level in the disposable collection bottle and replace it with a new one in good time.
- 3.17 Do not attach a continuous supply of device; the device operates in 30 minutes ON, followed 30 minutes OFF cycles.  
We require keeping alternative means of aspiration ready in case of appliance failure.
- 3.18 Disconnect the unit from socket before cleaning.
- 3.19 Do not immerse the device in water.
- 3.20 Do not use or store outside of specified environmental conditions.
- 3.21 To avoid mechanical or electrical damage, do not drop the unit and accessories.
- 3.22 Note: To ensure uninterrupted operation of the device when the device in ON cycles, place power cord so they cannot become disconnected during treatment. Ensure that power cord is routed safely.
- 3.23 Always visually inspect the device prior to placing the device to assure that no secretions are blocking vent openings.  
Keep ventilation openings, in the device enclosure, clear of obstruction.  
Keep vent openings from wall and any obstruction for min. 300mm.
- 3.24 Do not operate this device in a stationary recreational vehicle, boat, or motor home or similar places.  
Do not use the device while taking a bath.  
Do not place the device where it can fall into water.  
Do not immerse the device in water or other liquids.  
Do not use the device when it has fallen into water. Unplug it immediately.  
Do not use the device under rain.  
Do not use accessories not recommended by the manufacturer.  
Place the device on a flat and solid surface in such way that no air openings are blocked and incline or overturn are occurred.



- 3.25 The device must be used for the designated purpose only.
- 3.26 Install a new canister before testing for vacuum over -40kPa (-300mmHg) to minimize the possibility of implosion, which can occur when a canister is aged or damaged.
- 3.27 Before stop the phlegm suction unit, please make sure the fluids in the suction tube are suctioned to the bottle to prevent it from flowing back to the body of patients.
- 3.28 For safe operation, the phlegm suction unit must always be positioned below the patient's breathing system.

#### **Cautions:**

- **The device must be used with CE-marked parts, DO NOT use attachments not recommended by manufacture.**
- **Before use, check the device for proper assembly. All parts should be seated firmly in place.**
- **Do not expose the device to a heat source.**
- **Use the unit intermittently. Maximum operating period: 30minutes. Rest period: 30minutes.**
- **DO NOT use when sleepy or drowsy.**
- **Improper use of the grounding plug can result in a risk of electrical shock.**
- **Ground reliability can only be achieved when the power cord is connected to an equivalent receptacle marked "Hospital Grade".**

## Section 4 How to use the electrical suction unit

### Suction Device Picture and Symbols

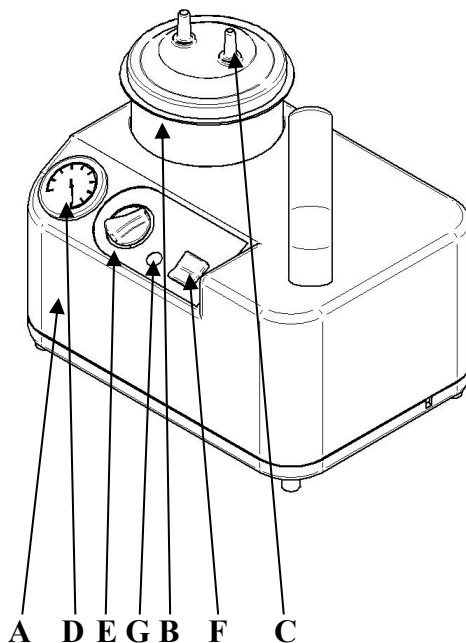

- A. Suction Device
- B. Suction Bottle
- C. Connection tubes
- D. Vacuum Pressure Value Reader
- E. Pressure Regulator
- F. Power Indicator
- G. Running Indicator

### Contraindications

It is contraindicated in the presence of:

- Abortion Surgery
- Necrotic tissue
- Untreated osteomyelitis
- Malignancy (with exception to enhance quality of life)

- Untreated malnutrition
- Exposed arteries, veins, or organs

## **Precautions**

Precautions should be taken for patients who care or may be:

- Receiving anticoagulant therapy
- Suffering from difficult hemostasis
- Untreated for malnutrition
- Non-compliant or combative

## **Warning: Before each use: please check**

### 1. Tube connection and leakage check

**Method:** Turn clockwise the regulator and block the inlet with finger or rubber tip, or fold and pin the suction tube. Start the machine. If there is no abnormal sound while it's running and the indicator of the pressure gauge go up rapidly to max pressure, then there is no leak, otherwise there is leak problem. Please do this check every month.

**Solution:** In case of leak, check each connection tube and make sure there is no leak on it one by one. Reconnect the tube where leak is found or replace the tube to get rid of leak.

### 2. Check on connection tube and found if there is any block

**Method:** Start the machine and connect the suction tube. The negative pressure is below 0.06Mpa if F6 suction tube is connected; the negative pressure is below 0.04Mpa if F8 suction tube is connected; the negative pressure is below 0.03Mpa if F12 suction tube is connected. There is no block on the tube in above cases, otherwise there is block and need clearance. Please check it every month.

**Solution:** Clean the tube regularly and replace it when necessary.

### 3. Overflow mechanism check

**Method:**

- a. Open the jar lid, clean the orifice and get the rubber tip on the buoyant flat. The rubber tip will not distort and break and connect with the buoyant well. The buoyant can flow flexibly in its frame

and there is no block.

- b. Lift the lid to make the buoyant perpendicular with the liquid and lower the lid slowly, then the buoyant can flow in the its frame.
- c. Tighten the lid, connect the suction tube onto the inlet, and turn one the regulator tight to get the suction unit running.

#### 4. Filter check and replacement

Method: Check the filter regularly and see if the filter film gets dark. Replace it with the air filters we supply. The check period is up to the use frequency and is not supposed to be more than one month.

#### 5. Outside cable check

Method: Check the outside cable of the machine to see if there is any exposure, break or short-circuit. Replace it in time if found. Please check it each time before use.

## Suction Settings

Setting the suction level is a decision that the health care provider must make based on an individual assessment if the particular wound. These general guidelines should be adhered to:

40-80mmHg is the recommended therapeutic pressure range.

Lower levels of suction are generally effective and more tolerable.

The suction level should never be painful. If the patient reports discomfort with the suction level, it should be reduced.

## Adjusting Vacuum

Vacuum may be adjusted by turning the pressure clockwise or anti-clockwise on the control panel. The pump will maintain the preset vacuum level without stopping until paused or switched off.

**Note: Displayed pressure values may vary during therapy and are a normal indication of pump functionality.**

**After use:**

- (1) Suction saline solution containing 9g/l sodium chloride to clean the tube before turning off the machine.
- (2) After turn off the machine, pour out the liquid, clean the jar and clean it with soft brush or cloth, then clean and disinfect them with water.

**Cautions: If collection bottle is glass vessel, don't let it collide with the sharp things, and avoid falling onto the ground.**

**Problems Analysis and Trouble Shooting**

Item	Problem	Cause Analysis	Solution	Remarks
1	Max negative pressure <math><0.075\text{MPa}</math>	<ol style="list-style-type: none"> <li>1) Leak in the lid of the jar.</li> <li>2) Leak in the connection tubes.</li> <li>3) The adjustment valve becomes loose.</li> </ol>	<ol style="list-style-type: none"> <li>1) Clean the lid of the jar, and turn it tight</li> <li>2) Reconnect the tubes again</li> <li>3) Tighten the adjustment valve</li> </ol>	<ol style="list-style-type: none"> <li>1) Inside parts should be checked by professionals.</li> <li>2) Replace the soft suction tubes when it ruptured.</li> </ol>
2	Negative pressure >math>>0.04\text{Mpa}</math>, but the gravitation of the tube opening is reduce or disappear.	<ol style="list-style-type: none"> <li>1) Overflow device was turned off.</li> <li>2) The tubes are jammed.</li> <li>3) Air filter is jammed.</li> </ol>	<ol style="list-style-type: none"> <li>1) Turn off the machine, turn anti-clock wisely the pressure regulator, and tighten it when the negative pressure reduces.</li> <li>2) Dredge, clean or change the soft tube.</li> <li>3) Change the air filter.</li> </ol>	<ol style="list-style-type: none"> <li>1) Empty the liquid in the jar in time.</li> <li>2) The blue marked side on the air filter is the inlet.</li> </ol>
3	The power indicator does not	<ol style="list-style-type: none"> <li>1) Cable pin loose</li> </ol>	<ol style="list-style-type: none"> <li>1) Mend or replace the</li> </ol>	Check the machine by the

	light	2) Fuse ruptured 3) The indicator light doesn't work.	plug. 2) Replace the fuse 3) Replace the indicator light.	professionals.
4	Fuse ruptured	1) Voltage over standard 2) Failure of the internal circuits. 3) Relay failure 4) Pump resistance, the current increase.	1) Check the circuit, and solve the problem 2) Adjust or replace the relay. 3) Check the pump and machine.	

**Caution!**

**As a condition of use, this device should only be used by qualified and authorized personnel. The user must have the necessary specialist knowledge of the specific medical application for which it is being used.**

**Construction and Working Mechanism**

It adopts oil-free piston pump to avoid oil and smoke pollution. Complete plastic panel, good anti-erosion performance, low noise, large flux, optional manual and pedal switch design gives easy maneuverability and transportation to this fashionable suction unit. It can successfully prevent fluid flow back to the pump due to the overflow control mechanism. It can be adjusted to your desired negative pressure with the help of the pressure regulator.

**Principle technical data:**

- a) Suction pump: piston pump
- b) Max negative pressure:  $\geq 0.075\text{MPa}$
- c) Adjustable negative pressure:  $0.02\text{MPa}$  to Max negative pressure
- d) Pumping rate:  $\geq 15\text{L/min}$
- e) Bottle capacity: 1000ml/pc
- f) Noise:  $\leq 65\text{dB(A)}$
- g) Power: AC 220-240V 50/60HZ or AC110V 60HZ

- h) Power consumption:  $\leq 90$  VA
- i) Outside Dimension: 340\*260\*285 mm
- j) Fuse (9E-A): F2AL, AC 250V
- k) Fuse (9E-B): F3AL, AC 250V
- l) Weight (9E-A): 3.9kg
- m) Weight (9E-B): 5.2kg
- n) Electric safety requirement: Class II , Type B equipment.

### **Normal Working Conditions:**

Environment Temperature: 5- 40°C

Relative Humidity:  $\leq 80\%$  (non-condensing)

Air Pressure: 70-106KPa

**Note: If the device has been at temperature below freezing, the device must be brought to room temperature for at least 4 hours prior to use or the pump unit may be damaged.**

### **Installation and Test**

#### **1. Unpacking inspection**

Before installation and test of the product, first check if the appearance is in good condition and the items included in the package to see if it's identical with the manual list. Please immediately contact the authorized dealer or the manufacturer in case of missing or damage.

#### **2. Power connection**

Take out the power cable and insert the cable pin into the slot of power. The power indicator turns on when the power is connected.

**Warning: The cable pin is intended for power plug in and shut up. The power outlet must be safely connected to underground.**

#### **3. Checking the tubes**

Turn the pressure regulator clockwise and block the suction area with fingers or rubber tips or by folding and holding tight the hoses. Turn on the suction switch to run it. When the hoses is in right connection, there is no abnormal sound and the panel needle will increased to max negative pressure rapidly; Unblock the suction area or loosen the tubes, the needle will indicate to below 0.02MPa.

**Note: Care must be taken to ensure tubing is installed completely and without any kinks to avoid leaks in the suction circuit.**

#### **4. Negative pressure adjustment**

Block the suction area and turn on the suction switch, the pressure panel will read during 0.02Mpa and max negative pressure while turning the pressure regulator clockwise.

Use the pressure regulator to monitor the negative pressure needed for the suction in surgical operations.

The negative pressure increases while turning the pressure regulator clockwise.

The negative pressure must be lower than 0.02Mpa before turning off the suction switch.

#### **5. Check and test overflow control mechanism**

- (1) Loosen the jar lid and clean the valve orifice. Then level down the valve rubber tip on the buoyant so that the valve rubber tip must not be crooked, broken, kinked etc and has a good link with the buoyant. The buoyant is supposed to move flexibly in the buoyant frame and there is no counter-force.
- (2) Lift the jar lid to get the buoyant perpendicular to the water. Lower the lid slowly until the buoyant floats on the water.
- (3) Tighten the jar lid. Connect the suction tube onto the suction area, turn clockwise the pressure regulator and run the suction unit.
- (4) Drop the suction tube into a bucket of clean water or do it in similar condition, the suction unit will suck the water into the jar with overflow control mechanism. The buoyant will rise with the going up of the water level. The suction will stop when the valve shuts. The water level varies with different suction methods.
- (5) Turn anti-clockwise the pressure regulator and turn off the suction switch. Open the bottle lid and empty the jar. The buoyant should be at the bottom of the buoyant frame and the valve orifice is open when the bottle lid is retightened.

The overflow control mechanism works in the above circumstances and is suitable for surgical operations.

The following conditions must be handled with CARE.

- (1) In two cases the liquid level still rises when the overflow control mechanism is closed:



- a. Due to the remaining negative pressure inside the jar.
- b. The valve orifice is not completely closed.

In previous circumstance, the liquid level will stop going up when the suction tube leaves the liquid being suctioned and put into it again. In the later circumstance, the liquid level still rises. Be careful with this condition. Lift the suction tube from the liquid being suctioned when the jar is almost full. Turn off the suction switch to stop suction and find the cause for valve failure.

- (2) The buoyant is easy to be sucked onto the valve when the valve closes. This is caused by the negative pressure in the tubes. Turn anti-clockwise the pressure regulator or turn off the suction unit (to release the negative pressure in the tubes). The buoyant will drop from the valve due to the gravity. (Pulling down the buoyant by hand is forbidden in case the rubber tip disconnect with the buoyant.)
- (3) Release the negative pressure before opening the jar lid when the suction switch is turned off.
- (4) Using the suction unit without overflow control mechanism and soft tubes is forbidden.

### **Cut off the power**

Turn off the switch on the suction unit. Pull the cable pin out of the power slot and cut off the power.

### **Use Method and Maintenance**

- a. Before use the machine, according the installation and adjustment procedures for inspection, to ensure good performance before connecting disinfected soft suction tube and peritoneal catheter tube.
- b. Before use, adjust the negative pressure by pressure regulator, and pay attention to the level of the liquid.
- c. When the suction volume is not large, under normal circumstances, the liquid is not allowed to enter other spare jars. If the liquid level rose to the former level calibration jars of liquid storage capacity when (tilt 10 degrees still applicable) should stop there, Pour out and clean the storage jar.
- d. When suction a large volume, it has to use the spare jar, pour out the liquid before overflow device works. Otherwise, Level will help buoy up until the valve closed, causing suction to stop automatically.

- e. If the over flow device is closed while the liquid continues to raise, please check with “inspection and testing of the overflow device”.

**Warning: The suction device is unsuitable for use in areas where there is danger of explosion.**

1. Change the air filter

When the air filter sucks foam or dust, the color of filter’s film will be darker, and the gravitation will be reduced or disappear, but the negative pressure continue to rise to above 0.04Mpa, then the air filter needs to be changed. The customer should often change the air filter, and destroyed together.

2. Change fuse tube

The fuse tube is on the rear side of the pedestal. Turn off the power and counter-clockwise turn it when you change it.

3. The Maintenance of the machine

Close the suction machine and cut the power each time after use. Do not keep it unused for too long (no longer than 30 days).

## Section 5 Cleaning, disinfection and sterilizing

Adherence to facility directives concerning hygiene is of prime importance. The instruction supplied with all cleaning agents as well as sterilization and/or disinfection units must be followed. The following points are to be used as general guidelines.

### 5.1 Hygienic preparation

Hygienic preparation of the device and the accessories used must be carried out daily during use and before every change of patient. Observe the instructions for the disinfectant used. Refer to the cleaning, disinfection and hygienic preparation instructions packaged with the accessories.

Be sure to carry out a functional check after every hygienic preparation

### 5.2 Cleaning, disinfecting and sterilizing

**WARNING: To avoid electrical shock, always unplug the device power cord before cleaning the device.**

**CAUTION: Do not immerse the device in liquid or allow any liquid to enter the enclosure, vent opening, or any openings.**

Unplug the device and clean the bottle holder surface and exterior of the enclosure as needed using a cloth dampened with water and a mild detergent. Allow the device to dry completely before plugging in the power cord. The outside of the pump should be cleaned with a damp cloth. Cleaning agents and disinfectants should not be used in an undiluted form. Ensure that the cleaning agent is compatible with plastics.

#### **Empty the Suction Canister as follows:**

- Remove the canister from its bracket and empty as instructed by Physician or Healthcare Professional.
- The waste are biohazard materials which should be disposed of properly to avoid injury or contamination
- If a sample is spilled on the device, wipe up immediately and apply disinfectant.
- Handle waste properly, according to legislation on water pollution, and on the treatment of drainage and waste matter.

- Waste, suction canister, collection bottle lid, patient tubing, are potentially hazardous and can cause injury, illness, or death. Wear appropriate personal protective equipment when handling waste (e.g., safety glasses, gloves, or protective clothing). Canister with lid and patient tubing are single patient use only.
- Dispose of Bio-waste products as described by your Healthcare Professional or Healthcare Facility protocol and comply with all local, state/provincial, or national laws and regulations related to wastes storage, handling, and disposal.
- The tubing inside device and port connected to collection bottle cannot be cleaned, if it becomes contaminated or clogged, the device must not be used, call authorized representative or manufacturer!
- If device is used for treatment of infectious disease, consult your Physician or Healthcare Professional for recommended procedures for proper disposal.

**For Collection canister:**

- 1) Cleaning in warm water with mild house-hold cleaner;
- 2) Disinfecting by immerse in disinfecting solution recommended in instruction manual packaged with the accessories and verified by the health care professional and clinic verification.
- 3) Rinse in washing machine, Rinse at up to 95°C;
- 4) Sterilization: Hot steam sterilization up to 121°C, Sterilization with superheated steam at 121°C in units complying with EN 285, residence time 20 minutes.

**For Vacuum tube, Aspiration tube with fingertip**

Disposable item, re-use not permitted. Use new part for every treatment.

**5.3 Functional check**

Functional check should be performed before each treatment and after use (clean, disinfect and/or sterilize the unit and its parts) and after all repairs. If the functional check reveals defects or deviations from the specified values, the device must not be used again until the faults have been rectified. We therefore recommend that you always keep a stock of accessories.

- Check that all tubes and the individual parts of the collection canister are

- in perfect condition. Any damaged or worn parts must be re-placed.
- Check that all tubes are securely connected and the disposable collection bottle is firmly installed and correctly
  - Switch on the device
  - Use your thumb to hold the suction nozzle closed
  - Switch on the aspirator and select the maximum vacuum of  $-0.8$  bar by turning vacuum control fully to the right. The device must reach this vacuum in not more than 20 seconds. If the aspirator takes more than 20 seconds to reach this vacuum, its suction capacity is reduced.  
Check for possible faults (see “Troubleshooting”) and call manufacturer.
  - Switch off the device and unplug the device.

## 5.4 Changing fuses

1. Unscrew the cover of fuse holder at the rear side of the device.
2. Remove the faulty fuse. The fuses are identified on the fuse body and adjacent to fuse holder.
2. Insert a new fuse. Always use approved fuses.
3. Screw the fuse holder cover.
4. Perform a functional check as the above section 4 and 5.

## Technical Data of Fuse

### Warning:

- **When operating, transporting, repairing, or disposing of 9E-A&9E-B and its accessories, the risk of infectious liquids being aspirated or contaminated of the pump assembly through.**
- **Incorrect use cannot be eliminated. Universal precaution should be observed whenever.**
- **Working with potentially contaminated parts or equipment.**
- **No liquid may enter the device. If any liquid penetrate the device contact your distributor for assistance.**
- **The pump should be visually inspected before each use, including the overflow control filter and the suction bottle and tubing.**

## Storage

The device should be stored in a clean and dry place where the temperature is below  $25^{\circ}\text{C}$  for optimal performance. During long term storage, turn on

the suction machine and start suction every month.

The use of suction personnel should be under the guidance of the medical person, used in strict accordance with the specification of the scope, procedure. Please contact the supplier or factory when you in doubt. (Please turn off the power before checking the circuit or opening the machine.)

**Transport and storage environmental conditions**

Environmental temperature range:  $-40^{\circ}\text{C} \sim 55^{\circ}\text{C}$

Relative humidity range:  $\leq 90\%$  (non-condensing)

Atmospheric pressure range: 50KPa~106KPa

The suction should be kept in no corrosive and good ventilation room, avoid violent bumping in transportation.

## **Section 6 Limited warranty**

### **After Sale Service**

Our company promises to guarantee the quality of the machine for 1 year from the sales date.

The following conditions are not covered in our service:

1. Damage or distortion caused by collision.
2. Water or rain enters the device.
3. Water, blood, phlegm or other liquid enter the pump due to careless use by users.

Notice: We can provide electrical circuit graphic and other information for repair if necessary.

Please contact the manufacturer if there is problem or doubt about the check and repair of the electrical circuits.

4. The check and repair of the electrical circuits can only be done by an electrician or a professional.

### **Warranty**

#### **What is covered by Warranty?**

We will at our option repair or replace any part found to be defective in material or workmanship without charge for parts and labor for original purchaser within 1 years of purchase.

#### **What is not covered by Warranty?**

This warranty does not apply to parts that have been damaged by accident, alteration, misuse, abuse, neglect, improper maintenance, vandalism, fire, theft, water, terrorism, war, or damage because of peril or other natural disaster. Warranty does not cover normal wear and tear, charges for pick up or delivery and service calls, or parts that are not our genuine replacement parts.

#### **How to obtain Warranty service?**

Warranty service is available with proof of purchase for the original purchaser through our company.

The provision set forth in this warranty provides the sole and exclusive remedy arising from the sale. We shall not be liable for incidental or

consequential damage or expense of any kind including but not limited to cost of equipment rental, and loss of profits.

Any implied warranty including implied warranty of merchantability or fitness for a particular purpose shall be limited in duration to the period of ownership by the original purchaser.

Some countries do not allow the exclusion or limitation of incidental or consequential damages, or limitations on how long an implied warranty lasts, so the above exclusions may not apply to you.

The limited warranty gives you specific legal rights, and you may have others that vary from province to province or country to country.



## Appendix A – Guidance and manufacturer’s declaration of EMC

### Electric Magnetic Information hint

WARNINGS AND CAUTIONS: Do not use in the presence of devices generating high electromagnetic fields such as magnetic resonance imaging (MRI) equipment.

Operation of the device may be adversely affected by

- Electromagnetic fields exceeding the level of 3V/m in the test conditions of EN 60601-1-2;
- The operation of high frequency (diathermy) equipment;
- Defibrillators, or short wave therapy equipment;
- Radiation (e.g., x-ray, CT)

**Attention: Please use the device according to electric magnetic information in list.**

<b>Guidance and manufacture’s declaration – electromagnetic emission</b>		
The <i>9E-A &amp; 9E-B Suction Machine</i> is intended for use in the electromagnetic environment specified below. The customer of the user of the <i>9E-A &amp; 9E-B Suction Machine</i> should assure that it is used in such and environment.		
<b>Emission test</b>	<b>Compliance</b>	<b>Electromagnetic environment – guidance</b>
RF emissions CISPR 11	Group 1	The <i>9E-A &amp; 9E-B Suction Machine</i> uses RF energy only for its internal function. Therefore, its RF emissions are very low and are not likely to cause any interference in nearby electronic equipment.
RF emission CISPR 11	Class B	The <i>9E-A &amp; 9E-B Suction Machine</i> is suitable for use in all establishments, including domestic establishments and those directly connected to the public low-voltage power supply network that supplies buildings used for
Harmonic emissions IEC 61000-3-2	Class A	
Voltage fluctuations/ flicker emissions	Complies	

IEC 61000-3-3		domestic purposes.	
<b>Guidance and manufacturer's declaration – electromagnetic immunity</b>			
The <i>9E-A &amp; 9E-B Suction Machine</i> is intended for use in the electromagnetic environment specified below. The customer or the user of <i>9E-A &amp; 9E-B Suction Machine</i> should assure that it is used in such an environment.			
<b>Immunity test</b>	<b>IEC 60601 test level</b>	<b>Compliance level</b>	<b>Electromagnetic environment - guidance</b>
Electrostatic discharge (ESD) IEC 61000-4-2	±6 kV contact ±8 kV air	±6 kV contact ±8 kV air	Floors should be wood, concrete or ceramic tile. If floor are covered with synthetic material, the relative humidity should be at least 30%.
Electrical fast transient/burst IEC 61000-4-4	±2 kV for power supply lines	±2kV for power supply lines	Mains power quality should be that of a typical commercial or hospital environment.
Surge IEC 61000-4-5	±1 kV differential mode ±2 kV common mode	±1 kV differential mode ±2 kV common mode	Mains power quality should be that of a typical commercial or hospital environment.
Voltage dips, short interruptions and voltage variations on power supply input lines IEC 61000-4-11	<5% $U_T$ (>95% dip in $U_T$ ) for 0.5 cycle  40% $U_T$ (60% dip in $U_T$ ) for 5 cycles  70% $U_T$ (30% dip in $U_T$ ) for 25 cycles  <5% $U_T$ (>95% dip in $U_T$ ) for 5 sec	<5% $U_T$ (>95% dip in $U_T$ ) for 0.5 cycle  40% $U_T$ (60% dip in $U_T$ ) for 5 cycles  70% $U_T$ (30% dip in $U_T$ ) for 25 cycles  <5% $U_T$ (>95% dip in $U_T$ )	Mains power quality should be that of a typical commercial or hospital environment. If the user of the <i>9E-A &amp; 9E-B Suction Machine</i> requires continued operation during power mains interruptions, it is recommended that the <i>9E-A &amp; 9E-B Suction Machine</i> be powered from an uninterruptible power supply or a battery.

		for 5 sec	
Power frequency magnetic field IEC 61000-4-8	3A/m	3A/m	Power frequency magnetic fields should be at levels characteristic of a typical location in a typical commercial or hospital environment.
<b>NOTE: <math>U_T</math> is the a.c. mains voltage prior to application of the test level.</b>			

**Guidance and manufacture’s declaration – electromagnetic immunity**

The *9E-A & 9E-B Suction Machine* is intended for use in the electromagnetic environment specified below. The customer or the user of *9E-A & 9E-B Suction Machine* should assure that it is used in such an environment.

<b>Immunity test</b>	<b>IEC 60601 test level</b>	<b>Compliance level</b>	<b>Electromagnetic environment - guidance</b>
Conducted RF IEC 61000-4-6	$3V_{rms}$ 150kHz to 80MHz	$3V_{rms}$	Portable and mobile RF communications equipment should be used no closer to any part of the <i>9E-A &amp; 9E-B Suction Machine</i> , including cables, than the recommended separation distance calculated from the equation applicable to the frequency of the transmitter. <b>Recommended separation distance</b> $d = \left[ \frac{3.5}{V_1} \right] \sqrt{P}$ $d = \left[ \frac{3.5}{E_1} \right] \sqrt{P} \quad 80 \text{ MHz to } 800 \text{ MHz}$ $d = \left[ \frac{7}{E_1} \right] \sqrt{P} \quad 800 \text{ MHz to } 2.5 \text{ GHz}$ Where $P$ is the maximum output power rating of the transmitter in watts (W) according to the transmitter
Radiated RF IEC 61000-4-3	$3V/m$ 80MHz to 2.5GHz	$3V/m$ 80MHz to 800MHz  $3V/m$ 800MHz to 2.5GHz	

			<p>manufacturer and <math>d</math> is the recommended separation distance in metres (m).</p> <p>Field strengths from fixed RF transmitters, as determined by an electromagnetic site survey,<sup>a</sup> should be less than the compliance level in each frequency range.<sup>b</sup></p> <p>Interference may occur in the vicinity of equipment marked with the following symbol: </p>
--	--	--	---------------------------------------------------------------------------------------------------------------------------------------------------------------------------------------------------------------------------------------------------------------------------------------------------------------------------------------------------------------------------------------------------------------------------------------------------------------------------

**NOTE 1 At 80MHz and 800MHz, the higher frequency range applies.**

**NOTE 2 These guidelines may not apply in all situations. Electromagnetic propagation is affected by absorption and reflection from structures, objects and people.**

<sup>a</sup> Field strengths from fixed transmitters, such as base stations for radio (cellular/cordless) telephones and land mobile radios, amateur radio, AM and FM radio broadcast and TV broadcast cannot be predicted theoretically with accuracy. To assess the electromagnetic environment due to fixed RF transmitters, an electromagnetic site survey should be considered. If the measured field strength in the location in which the *9E-A & 9E-B Suction Machine* is used exceeds the applicable RF compliance level above, the *9E-A Suction Machine* should be observed to verify normal operation. If abnormal performance is observed, additional measures may be necessary, such as reorienting or relocating the *9E-A & 9E-B Suction Machine*.

<sup>b</sup> Over the frequency range 150kHz to 80MHz, field strengths should be less than 3V/m.

**Recommended separation distances between portable and mobile RF communications equipment and the *HUMMER<sup>a</sup> 9E-A & 9E-B Suction Machine***

The *9E-A & 9E-B Suction Machine* is intended for use in an electromagnetic environment in which radiated RF disturbances are controlled. The customer or the user of the *9E-A & 9E-B Suction Machine* can help prevent electromagnetic interference by maintaining a minimum distance between portable and mobile RF communications equipment (transmitters) and the *9E-A & 9E-B Suction Machine* as recommended below, according to the maximum output power of

the communications equipment.

Rated maximum output power of transmitter (W)	Separation distance according to frequency of transmitter (m)		
	150 kHz to 80 MHz	80 MHz to 800 MHz	800 MHz to 2.5 GHz
	$d = \left[ \frac{3.5}{V_1} \right] \sqrt{P}$	$d = \left[ \frac{3.5}{E_1} \right] \sqrt{P}$	$d = \left[ \frac{7}{E_1} \right] \sqrt{P}$
0.01	0.117	0.117	0.233
0.1	0.38	0.38	0.737
1	1.17	1.17	2.33
10	3.8	3.8	7.37
100	11.7	11.7	23.2

For transmitters rated at a maximum output power not listed above, the recommended separation distance  $d$  in metres (m) can be estimated using the equation applicable to the frequency of the transmitter, where  $P$  is the maximum output power rating of the transmitter in watts (W) according to the transmitter manufacturer.

**NOTE 1 At 80MHz and 800MHz, the separation distance for the higher frequency range applies.**

**NOTE 2 These guidelines may not apply in all situations. Electromagnetic propagation is affected by absorption and reflection from structures, objects and people.**

## **Appendix B – Periodic safety overflow mechanism check**

### **Check Method:**

Tighten the lid, connect the suction tube onto the inlet, and turn one the regulator tight to get the suction unit running.

Drop the suction tube into a bucket of clean water or do it in similar condition, the suction unit will suction the water into the jar with overflow control mechanism. The buoyant will rise with the going up of the water level. The suction will stop when the valve shuts. The water level varies with different suction methods.

Turn anti-clockwise the pressure regulator and turn off the suction switch. Open the jar lid and empty the jar. The buoyant should be at the bottom of the buoyant frame and the valve orifice is open when the bottle lid is retightened.

The check period is once every week.



**Jiangsu Konsung Bio-Medical Science And Technology Co., Ltd.**

Address: NO.8, Shengchang West Road, Danyang Development Zone,  
Jiangsu Province, 212300, P.R. China

Tel: +86 511 86375968

E-mail: [info@konsung.com](mailto:info@konsung.com)

Website: [www.konsung.com](http://www.konsung.com)